



# Digital Thermostat



Installation and  
operating  
Instructions

## OVERVIEW

Thank you for purchasing this digital thermostat, designed to complement and enhance the operation of your Propex or Whale space heater.

This thermostat is designed to control the operation of your blown air heater whilst maintaining the desired cabin temperature. Air temperature is measured at the thermostat and when the ambient air temperature meets the set temperature will switch the heating function off. Should the ambient air temperature drop by approx. 2 degrees, as measured at the digital thermostat, so the heating function will be restarted. The thermostat will maintain this cycle until switched off.

For models for use with Gas only heaters a countdown timer function is available.

## COMPATIBILITY

Program 1 (Gas only Heaters)	Program 2 (Gas or Electric Heaters)
HS2000	HS2000e
HS2800	HS2202
HS2211	HS2212

## WHATS INCLUDED

Panel mounted Digistat, removable bezel, mounting template, instructions.

The digistat is designed to accept the decorative bezel manufactured by CBE in Italy, this is widely available in a variety of colours and finishes.



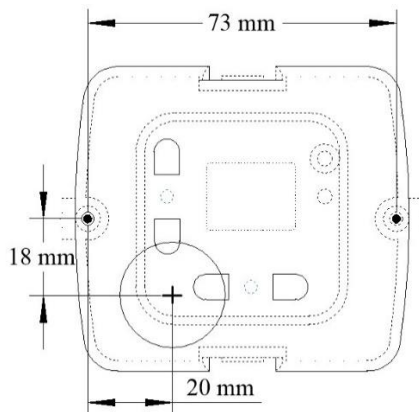

# INSTALLATION

- Ensure the appliance is isolated from electrical power sources before attempting any work with the heater.
- Select a suitable flat vertical location to mount the digistat, ideally at shoulder height whilst seated and away from sources of heat, like a fridge or hob, or cold draughts such as below windows or near door seals.
- Once the desired location is identified ensure you can get the harness from the heater to access the back of your panel.
- Using the guide below mark the centres for the two mounting holes plus the one for the thermostat loom.
- Drill two pilot holes to suit fixing screws being used. Drill a pilot hole for the digistat harness and check the back of the panel for clearance, once satisfied open-up to 22mm diameter.
- Push the connector(s) on the rear of the thermostat through the hole and fix the thermostat into position using the relevant screw positions.
- Take the 6 core loom (+3core for 'e' models) from the heater and connect to the plug on the rear of the thermostat ensuring that the latches are mating correctly.
- Clip the decorative frame into position.





## OPERATION – GAS ONLY HEATER



- Pressing the 'Gas Control'  button will power on the thermostat, the screen will illuminate and display the current ambient temperature.
- Using the up  and down  arrows on the left hand side will enable the desired room temperature to be set. As soon as an arrow is pressed the current 'set' temperature will be displayed.
- Once the set temperature is greater than the ambient (room) temperature the green LED will come on and the thermostat will call to the heater for heat.
- The heater will start its ignition cycle and when a flame is successfully established the red LED will illuminate.
- To turn off the heater press the Gas Control button.

## Countdown Timer

Pressing the countdown timer button  will bring onto the display the number of hours to countdown from, before the heater will start to operate.

- Repeated pressing of the button will allow you to toggle through 1 – 16 hours until the desired time is met.
- 5 seconds after the button has stopped being pressed then the timer will start counting down and the display will alternate between the hours and minutes remaining.
- Once the timer has reached zero the heater will start and operate.
- You do not need to switch on the Gas control button 
- To cancel the timer operation, wait until the countdown has started and press the timer  button again.

## OPERATION – GAS AND ELECTRIC HEATERS



### To operate on Gas

- Pressing the ‘Gas Control’  button will power on the thermostat, the screen will light up and display the current ambient temperature.

- Using the up ▲ and down ▼ arrows on the left hand side will enable the desired room temperature to be set. As soon as an arrow is pressed the current 'set' temperature will be displayed.
- Once the set temperature is greater than the ambient (room) temperature so the green LED will come on and the thermostat will call to the heater for heat.
- The heater will start its ignition cycle and when a flame is successfully established the red LED will illuminate.
- To turn off the heater press the Gas Control button.

## To operate on Mains Electric

- Press and hold the Power Level Button 
- The screen will illuminate and display the last set power level
- As you hold the button, so the screen will toggle through the available power settings

- E1 = 500W
- E2 = 1kW
- E3 = 2kW



- When the power level required is reached then release the button  and heater will start to operate at that setting.
- The display will alternate between ambient temperature and selected power level
- If the heater does not operate check to ensure the set temperature is above ambient by increasing the 'set' temperature using the up ▲ and down ▼ arrows.

## HEATER FAULT RESET

A heater fault will be displayed as a red flashing LED on the thermostat

**It is important you refer to the instruction manual that came with your heater to identify the cause of the fault.**

Once the fault has been identified and the cause addressed then the heater can be reset using the following method.

*For heaters manufactured from 2016 and prior to April 2018* – ensure the set temperature is above ambient. Press the gas control button  ON – then switch it OFF – then switch back ON. Within 2.5 seconds.

*For heaters manufactured from April 2018 – Switch the unit off. in the bottom right hand corner from the display is a small hole containing a concealed button. Using a paper clip or similar, carefully insert into the hole and gently press the button twice leaving 1 second between each press.*



## FAULT FINDING

Fault	Reason	Solution
No response from thermostat	Heater is not powered up	Check heater has power
Not responding to key Presses	Keys being pressed too quickly	Use a more positive key action
Thermostat does not immediately bring on green led.	Built in delay	Wait 2 seconds after desired temperature position is reached
Cannot reset fault on heater	Wrong reset sequence for heater being used	Check manual for heater.
Cannot reset fault on heater	Reset sequence being carried out too fast	Allow 1 second between ON activation

For further assistance please contact your supplying dealer.

Propex Heating and Leisure Ltd. Unit 10 Carvers Trading Estate, Ringwood, Hants. BH24 1JS

Tel 01425 486950

[www.propexheatsource.co.uk](http://www.propexheatsource.co.uk)

[sales@propexheatsource.co.uk](mailto:sales@propexheatsource.co.uk)